



WAM[®] AL TECHNOLOGY

— FOR —

ALUMINUM



Global **Refractory** Solutions



WAM[®] AL TECHNOLOGY

REDUCE COST IMPROVE QUALITY MINIMIZE MAINTENANCE

The WAM[®] AL technology consists of a family of products that address the diverse refractory needs of the aluminum industry. Each product incorporates properties that allow it to solve specific application issues associated with a variety of metal contact processes.

All products within this family are comprised of high purity synthetic materials with only trace amounts of silica (SiO_2) and other oxidizing compounds, which contribute to undesirable corundum formation. Each WAM[®] AL product exhibits excellent resistance to molten aluminum as a result of its unique chemical formulation.

This base technology is the building block for the family of products that allows for complete furnace lining designs which:

- **Reduce energy consumption**
- **Minimize required maintenance**
- **Increase furnace performance**
- **Lessen the total cost of ownership for your refractory linings**



BEAT THE CORUNDUM CONDRUM

Corundum forms as a result of aluminum metal reacting with the refractory. When excessive corundum forms, it reduces energy efficiency, furnace throughput, increases maintenance, and ultimately causes metal loss. Corundum growth can be minimized by limiting available oxygen sources, including components of refractory linings. This, in combination with managing heat sources, maintenance, and metal quality, can reduce your costs to produce.

Traditional refractory linings developed for the aluminum market may contain more than 30% silica. WAM[®] AL products contain less than 0.7% silica, reducing the possibility of corundum formation as a result of metal interaction with the refractory lining.

Operators can improve operational efficiency, reduce maintenance costs, and shorten cleaning outages. The WAM[®] AL family of products has been developed with installers in mind, so no special installation methods or equipment are required.



IMPROVE YOUR BOTTOM LINE

The total cost of a refractory is the sum of the cost to purchase the refractory, install the refractory, and maintain the refractory. The patented refractory technology in the WAM® AL family of products helps to inhibit the formation of corundum, which extends refractory life and reduces maintenance cost and downtime.

WAM® AL castables exhibit excellent insulating properties and exceptional resistance to thermal shock. Due to excellent corrosion resistance, this family of products increases furnace performance and energy savings compared to typical low cement castables. The WAM® AL family of products provides the lowest total cost of ownership by maintaining their thermal and non-wetting properties.

$$\frac{AL}{L} = \alpha_L \Delta T$$

**WAM® AL III
Steady State Heat Flow
with Heat Loss**

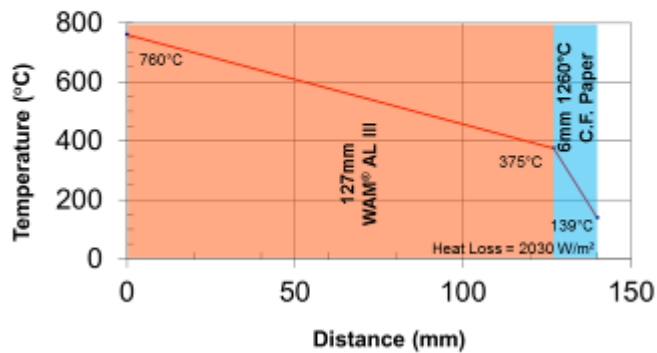

**65% Alumina Castable
Steady State Heat Flow
with Heat Loss**

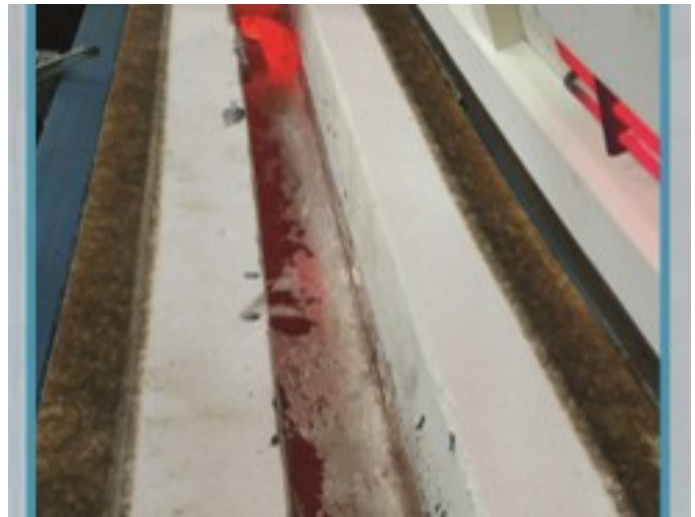
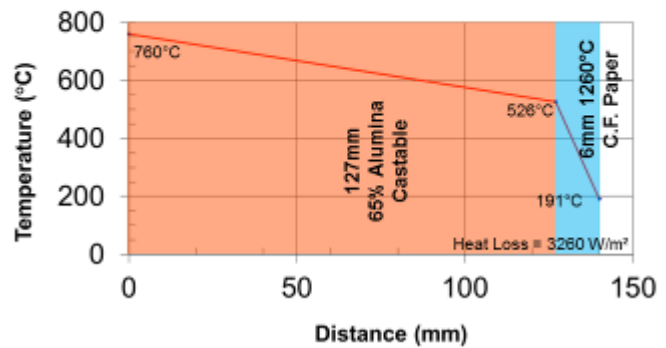



WAM[®] AL PRODUCT FAMILY

WAM[®] AL II - Castable

A medium density, low thermal conductivity castable for metal contact use in holding furnaces, melting furnaces, launders, transport vessels and ancillary metal handling applications.

WAM[®] AL II HDF - High Density

Dense, low water castable to address the need for high strength in impact areas, ramps, sills, and reverb sidewalls.

WAM[®] AL III - Castable

NEW generation WAM[®] AL product exhibits exceptional thermal shock resistance and improved consistency installation characteristics.

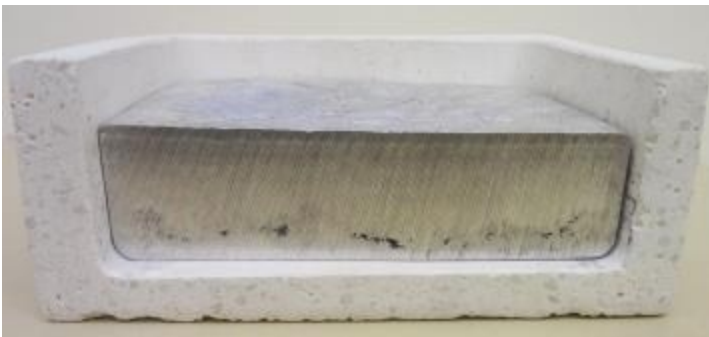

WAM[®] AL III aluminum contact testing



WAM[®] AL III vessel after metal has been removed

WAM[®] AL II G & WAM[®] AL II HDF G - Gun Mix

Gunning mixes for repairing existing metal contact linings.





STACKMELTER



STACK

- ARMORMAX® 70 SR (upper)
- MATRIFLO 85 ACX
- MATRIFLO 93 AC
- MATRIPUMP 72 ACX
- QUICK CAST® 61 ACX

BURNERS

- KAST TECH® 30
- LCF 798A
- MATRIPHOS 85 AC

ROOF

- MATRIPUMP 50
- MATRIPUMP AR 61
- KAST TECH® 30

ROOF

- KAST TECH® 30
- MATRIPUMP AR 61
- QUICK CAST® 62

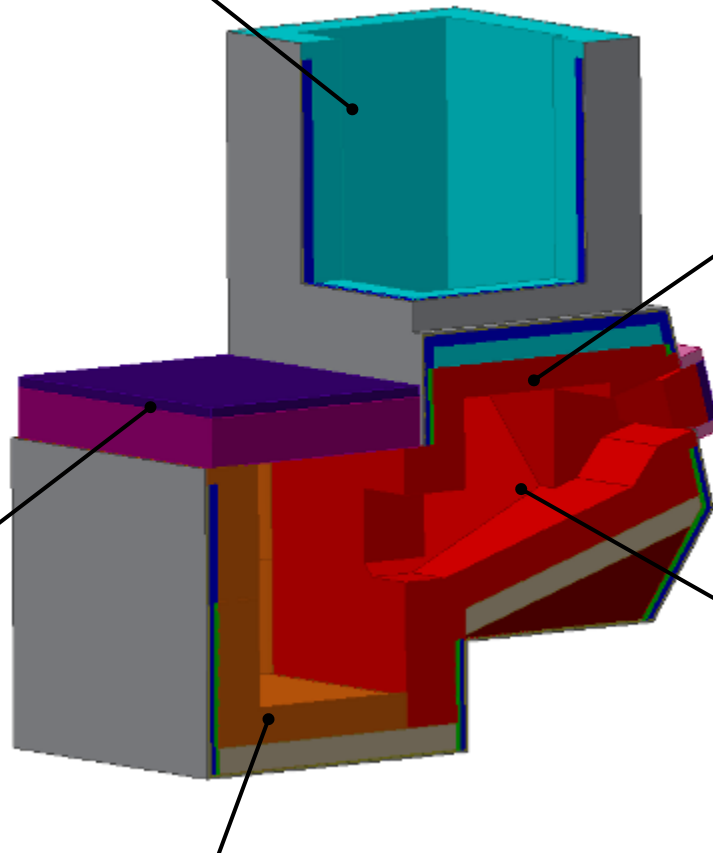

WALLS / HEARTH / RAMP

- WAM®AL II HDF
- MATRIFLO 85 ACX
- MATRIPUMP 72 ACX
- MATRIFLO 93 AC

HEARTH & WALLS

- WAM®AL II
- WAM®AL III
- WAM®AL II HDF
- QUICK CAST® 61 ACX
- QUICK-FIRE® 88
- MATRICAST 70 AC

REPAIRS

- WAM®AL II G
- WAM®AL II HDF G
- QUICK-FIRE® 85 G
- BETAGUN® ABR
- QUICK-FIRE® PATCH B



DIE CASTING HOLDER

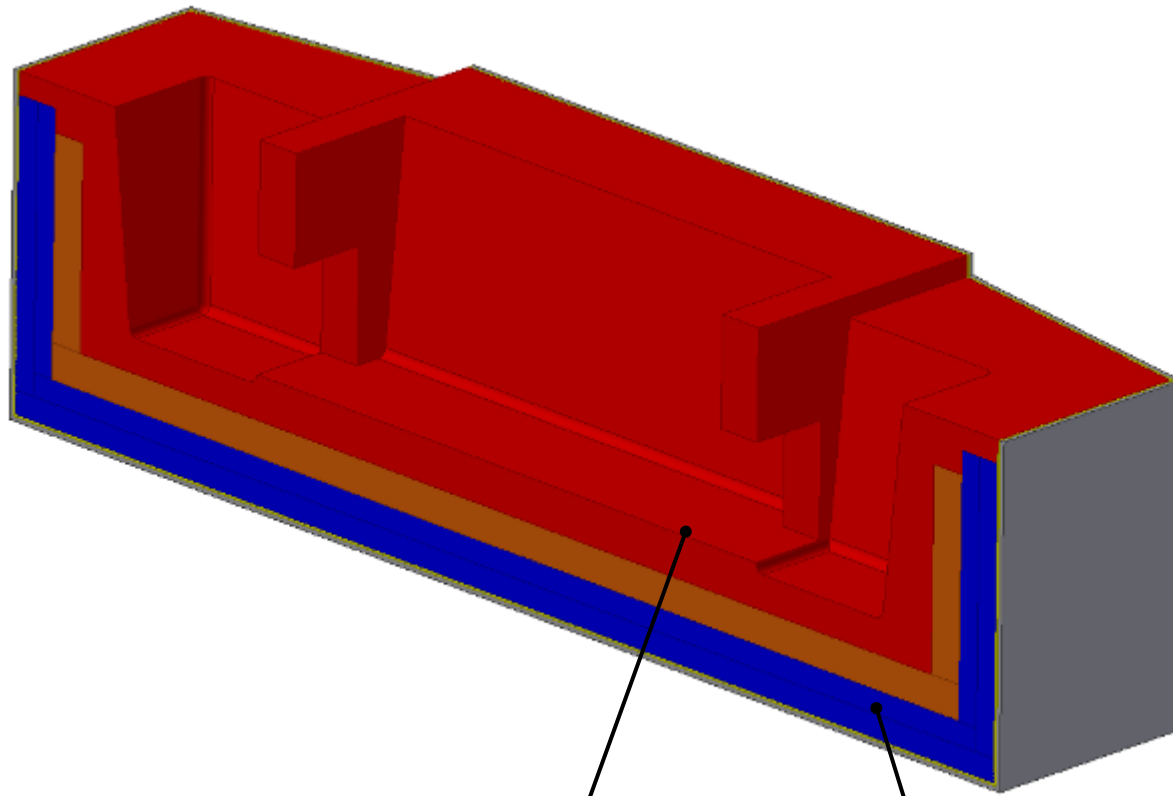

FURNACE LINING

WAM[®] AL II

WAM[®] AL III

MATRIPUMP 63 ACX

MATRICAST 70 AC

MATRIFLO 85 ACX

QUICK CAST[®] 61 ACX

QUICK-FIRE[®] 88

SAFETY LINING

DRI-LITE[®] 79AL-M

BETAMAX[®] 24 LT





TECHNICAL DATA

General Technical Data

	WAM® AL II Castable	WAM® AL II HDF Castable	WAM® AL III
Typical Water Required	18 - 23%	6.5 - 7.5%	17 - 21%
Material Required	1.73 g/cm ³ (108 lb/ft ³)	2.46 g/cm ³ (154 lb/ft ³)	1.76 g/cm ³ (110 lb/ft ³)
Maximum Recommended Service Temp.	1430°C (2600°F)	1650°C (3000°F)	1200°C (2200°F)
Installation Method	Vibration Casting	Vibration Casting	Vibration Casting

Chemical Analysis

	WAM® AL II Castable	WAM® AL II HDF Castable	WAM® AL III
Al ₂ O ₃	61.4%	64.3%	75.5%
SiO ₂	0.7%	0.4%	0.4%
CaO	26.7%	24.3%	22.7%
TiO ₂	0.3%	-	-
Fe ₂ O ₃	0.3%	0.1%	0.2
MgO	0.3%	0.5%	0.3
Alkalis (K ₂ O + Na ₂ O)	0.3%	0.4%	0.2
Other	10.0%	10.0%	-

Thermal Conductivity*

	WAM® AL II Castable	WAM® AL II HDF Castable	WAM® AL III
400°C (750°F)	0.76 W/mK (5.3 BTU·in / ft ² ·hr·°F)	-	-
815°C (1500°F)	0.69 W/mK (4.8 BTU·in / ft ² ·hr·°F)	1.24 W/mK (8.63 BTU·in / ft ² ·hr·°F)	0.7 W/mK (4.8 BTU·in / ft ² ·hr·°F)
1200°C (2200°F)	0.76 W/mK (5.3 BTU·in / ft ² ·hr·°F)	-	-

*Less than half of a 60% castable!



TECHNICAL DATA

Density

Temperature	WAM® AL II Castable	WAM® AL II HDF Castable	WAM® AL III
110°C (230°F)	1.98 g/cm ³ (123 lb/ft ³)	2.58 g/cm ³ (161 lb/ft ³)	1.98 g/cm ³ (124 lb/ft ³)
815°C (1500°F)	1.73 g/cm ³ (108 lb/ft ³)	2.46 g/cm ³ (154 lb/ft ³)	1.76 g/cm ³ (110 lb/ft ³)
1400°C (2550 °F)	1.71 g/cm ³ (107 lb/ft ³)	-	-

Modulus of Rupture

Temperature	WAM® AL II Castable	WAM® AL II HDF Castable	WAM® AL III
110°C (230°F)	7.3 MPa (1060 psi)	15.4 MPa (2230 psi)	8.2 MPa (1190 psi)
815°C (1500°F)	3.1 MPa (450 psi)	8.0 MPa (1170 psi)	3.9 MPa (570 psi)
1400°C (2550°F)	2.4 MPa (350 psi)	-	-

Cold Crushing Strength

Temperature	WAM® AL II Castable	WAM® AL II HDF Castable	WAM® AL III
110°C (230°F)	54.5 MPa (7900 psi)	101 MPa (14700 psi)	36.6 MPa (5300 psi)
815°C (1500°F)	27.7 MPa (4000 psi)	67.6 MPa (9800 psi)	26.4 MPa (3820 psi)
1400°C (2550°F)	16.1 MPa (2300 psi)	-	-

Permanent Linear Change

Temperature	WAM® AL II Castable	WAM® AL II HDF Castable	WAM® AL III
110°C (230°F)	-0.2%	-0.08%	-0.09%
815°C (1500°F)	-0.2%	0.0%	-0.2%
1400°C (2550°F)	-0.5%	-	-



ABOUT ALLIED



Allied Mineral Products is a world leader in the design and manufacture of monolithic refractories and precast shapes. With strong sales and service teams in the foundry, aluminum, steel, heat treat/forge and industrial markets, our success is based on our dedication to *Being There Worldwide with Refractory Solutions*.

Producing quality, consistent products is top priority at Allied and we have the products to meet your refractory needs. Our extensive product line includes innovative refractory technology and longstanding refractory alternatives.

Allied's focus on quality at every stage in the production process is unparalleled. A stringent raw material standard and global quality control testing before and after each batch is produced, provides customers with consistent products. We provide quick response times to any urgent request through flexible manufacturing systems at all our manufacturing facilities.

Global **Refractory** Solutions





RESEARCH & ENGINEERING

After gaining a detailed understanding of your specific needs, our team evaluates operating criteria and physical design parameters to create a detailed engineered design encompassing:

- Patented technologies
- Optimized product zoning
- Thermal models to optimize and validate designs
- Proven safety lining system designs
- Unique installation properties and techniques
- Leading edge refractory system designs

We're focused on developing new products, improving existing products and perfecting installation techniques. Our product development and testing is conducted in our state of the art research and technology center. We have an on-site gunning and shotcreting lab allowing extensive testing of installation properties.

As an innovative, technology-driven supplier we're devoted to providing customized refractory solutions for various industry operations. We offer a wide variety of high performance refractory products with superior raw material quality.

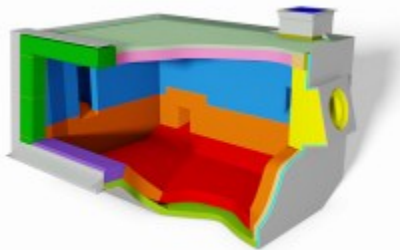

FEA Thermal Analysis



Flow Testing

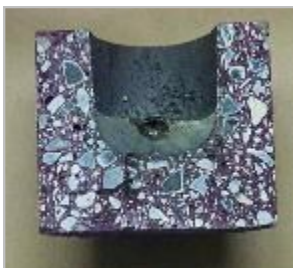

Contact Tests



Strength Tests



in our
element

process °C   **NOTES**

refractory



Σ



research



*



$$\frac{\Delta L}{L_0} = \alpha_L \Delta T$$

thermal expansion

Δ

+



= %

?

*



The Allied Difference

Being There Worldwide with Refractory Solutions





Corporate Headquarters

Columbus, Ohio USA

+1 614-876-0244

info@alliedmin.com

Global **Refractory** Solutions



Scan to view our locations

alliedmineral.com

