

# PRECAST

---

# REFRACTORY SHAPES



Global **Refractory** Solutions



Allied Mineral Products is a world leader in the design and manufacture of monolithic refractories and precast shapes. With strong sales and service teams in the foundry, aluminum, steel, heat treat/forge and industrial markets, our success is based on our dedication to *Being There Worldwide with Refractory Solutions*.

Producing quality, consistent products is top priority at Allied and we have the products to meet your refractory needs. Our extensive product line includes innovative refractory technology and longstanding refractory alternatives.

Allied's focus on quality at every stage in the production process is unparalleled. A stringent raw material standard and global quality control testing before and after each batch is produced, provides customers with consistent products. We provide quick response times to any urgent request through flexible manufacturing systems at all our manufacturing facilities.

## Global **Refractory** Solutions



**12** MANUFACTURING FACILITIES  
OVER **145** INTERNATIONAL SALES REPRESENTATIVES  
**3** RESEARCH AND TECHNOLOGY FACILITIES  
SALES ACTIVITY IN MORE THAN **130** COUNTRIES  
**7** PRECAST SHAPES FACILITIES





# RESEARCH & ENGINEERING

After gaining a detailed understanding of your specific needs, our team evaluates operating criteria and physical design parameters to create a detailed engineered design encompassing:

- Patented technologies
- Optimized product zoning
- Thermal models to optimize and validate designs
- Proven safety lining system designs
- Unique installation properties and techniques
- Leading edge refractory system designs

We're focused on developing new products, improving existing products and perfecting installation techniques. Our product development and testing is conducted in our state of the art research and technology center. We have an on-site gunning and shotcreting lab allowing extensive testing of installation properties.

As an innovative, technology-driven supplier we're devoted to providing customized refractory solutions for various industry operations. We offer a wide variety of high performance refractory products with superior raw material quality.

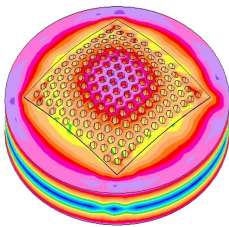
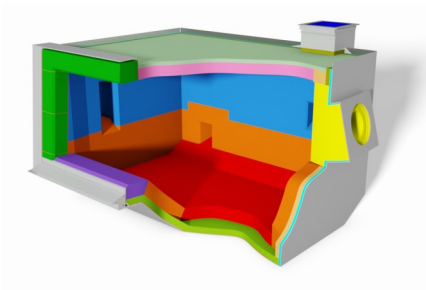

FEA Thermal Analysis

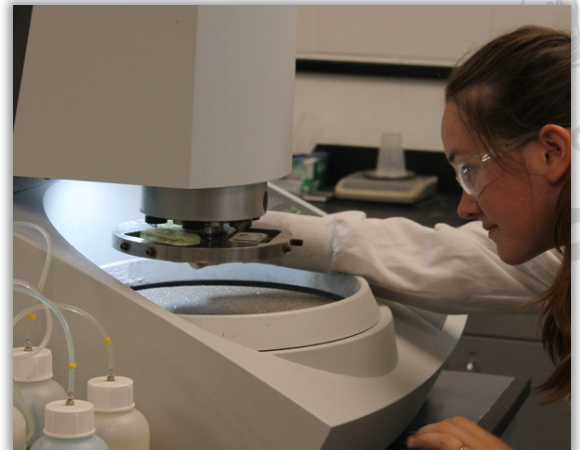

Flow Testing



Contact Tests



Strength Tests

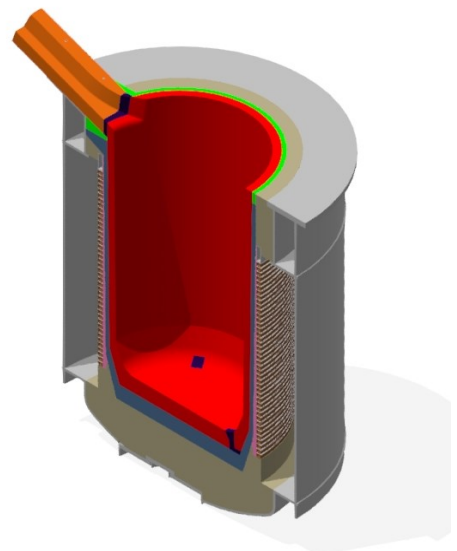



# PRECAST FACILITIES

With over 50 years of experience in refractory shapes production, we pride ourselves on delivering high quality shapes to our customers all over the world.

Our facilities have access to over 1,000 refractory product formulations to cater to the requirements of specific applications. We are solution driven with collaboration between sales, research, engineering and manufacturing.

- Extensive product offerings like METAL-ROK<sup>®</sup>, the ultimate ceramic-metal composite for shapes
- Shapes ranging from 1 kg to 15 metric tons (2 lbs to 10 tons)
- Engineering capabilities across the globe

Our application engineering capabilities allow us to design and manufacture complex pieces of virtually any shape and size. Precast shapes can be designed and created based on existing drawings or shape.

Some of our most popular shape capabilities include foundry crucibles, furnace structural parts, EAF deltas and spouts, tilters and skimmer blocks, incinerator shapes, and rotary furnace shapes.

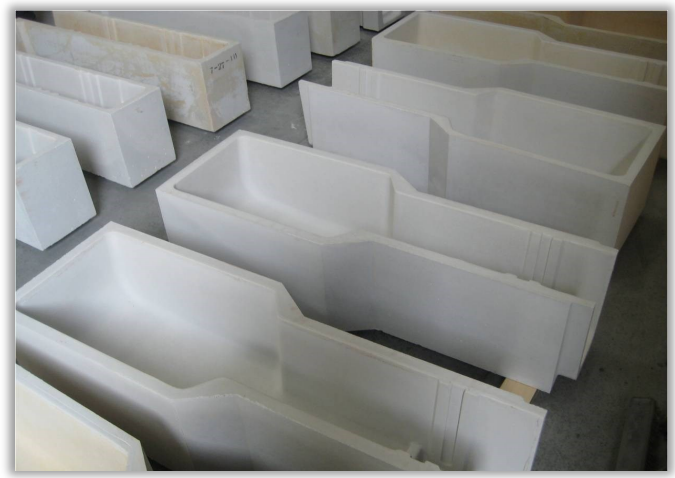
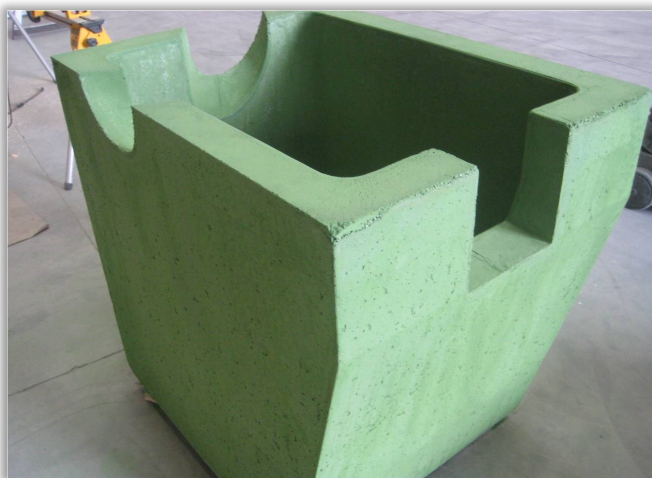



# PRECAST FACILITIES

process  
global  
refractory  
research

Allied's first precast shape facility was founded in 1995 in Columbus, Ohio after acquiring American Precast Refractories. This center was constructed specifically for forming, firing and finishing precast refractory shapes.



Columbus, Ohio USA



Pell City, Alabama USA

Expanding our precast shapes locations internationally allows customers to purchase locally sourced materials with lower cost estimates.



Tianjin, China



Tholen, The Netherlands



Germiston, South Africa



# FOUNDRIY INDUSTRY

process global refractory

Allied uses innovative technology to create unique precast shapes that withstand harsh temperature changes in molten metal transfer applications. Our customers have access to expert recommendations and are backed by extensive engineering and design capabilities. Allied's vast product catalog ensures the right product for your vessel and operating conditions.

## Foundry shapes

- Coreless Furnace
- Channel Induction Furnace
- Cupolas
- Gas-fired Furnace
- Resistance Rod Furnace
- Heat Treating & Forging Furnace
- Reverberatory Furnace
- Vacuum Tundishes
- Transfer Ladles
- Ductile Treatment Ladles
- Pouring Tundishes / Boxes
- Launder
- Centrifugal Casting Feed Equipment
- Impact Shapes

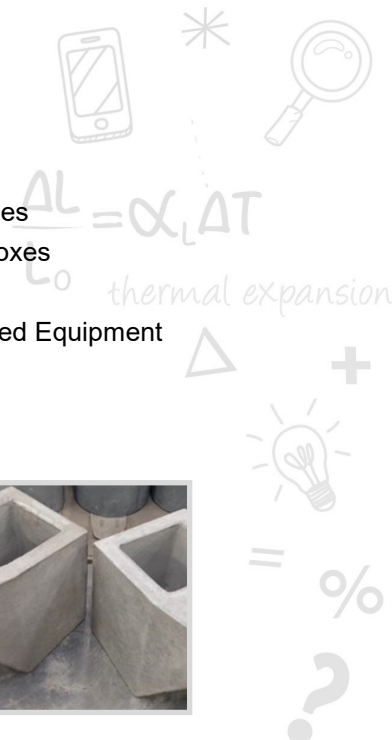



# ALUMINUM INDUSTRY

We have a large, diverse collection of refractory products designed specifically for the aluminum industry, ensuring a perfect material for each area of your furnace/vessel. We apply these standards of product specialization to our precast shapes, bringing high-performing, specialized pieces to your molten aluminum applications.

In 2010, Allied and Pyrotek joined efforts to better serve the aluminum industry with precast shape solutions. Some of our unique capabilities include:

- Reverberatory Furnaces
- Diecasting Holding Furnaces
- Runners
- Tundishes
- Funnels
- Custom Pouring Components
- Reverb Dome Covers
- X-ACT® Technology for Crucibles

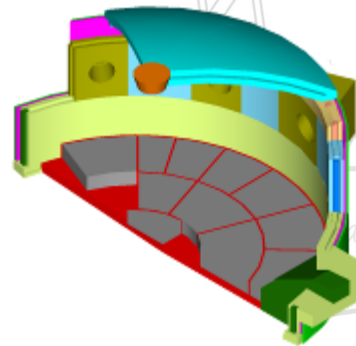



# HEAT TREATING & FORGING INDUSTRY

process  
refractory

Allied has several tradenamed refractories designed for use in the heat treating and forging industries. We use these industry-leading products to create customized precast shapes for high temperature applications.

## Our capabilities

- Car Decks
- Pier Blocks
- Burner Tiles
- Skid Rails
- Lintels
- Jambs
- Flues







# STEEL INDUSTRY

Allied's precast centers work closely with the engineering and research departments to enhance furnace productivity through design innovations. We offer a complete line of specialized precast, pre-fired refractory shapes for the steel industry including:

- Iron Troughs
- Runners
- Slag Runners
- Tilting Runners
- Transfer Equipment
- Blast Furnace Subhearth / Hearth
- EAF Roof Deltas
- EAF Spouts
- EAF Electrode Rings
- Skid Rails

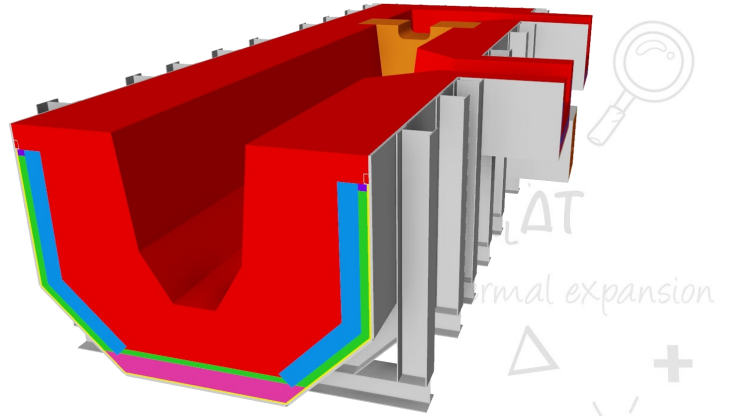



# INDUSTRIAL MARKET

process  
global  
refractory

Allied precast shape materials for industrial applications include a variety of durable, versatile products. One such product is METAL-ROK<sup>®</sup>, our ultimate ceramic-metal composite for pre-fired shapes. Allied's research and development team created METAL-ROK<sup>®</sup> to be strong and dependable in a variety of abrasive conditions. Additionally, we have an extensive product line of manufactured shapes specifically suited for the following:

- Asphalt Process
- Boilers
- Cement
- Hazardous & Bio-incineration
- Iron Ore Processing
- Incineration Process
- Lime Kilns
- Power Generation
- Waste to Energy Gasification Process



$$\frac{\Delta L}{L_0} = \alpha_L \Delta T$$

thermal expansion

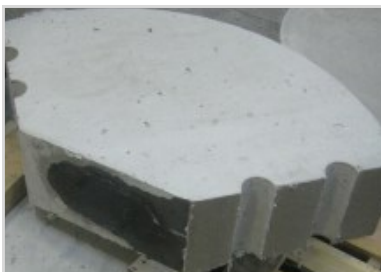
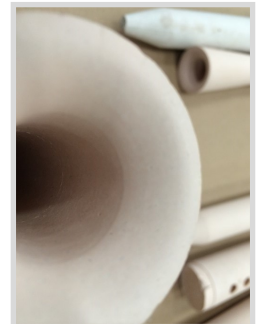
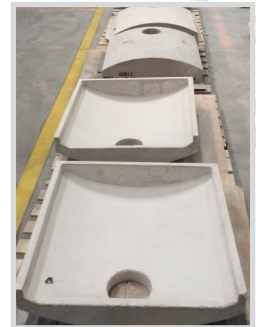



# HEARTH RELATED PRODUCTS

Precast shapes for the home and hearth industry are designed to be resistant to alkali attack, mechanical abuse and high temperatures. Allied can create unique precast shapes for the following:

- Fireplaces
- Woodstoves
- Pellet Stoves
- Bio-mass Stoves
- Indoor/Outdoor Wood Boilers
- Gasifiers

process  
global  
refractory  
thermal expansion

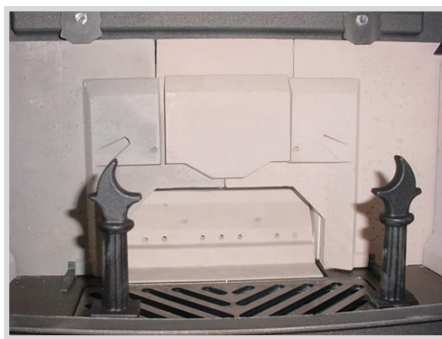
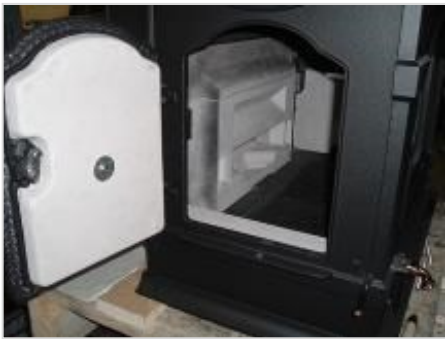
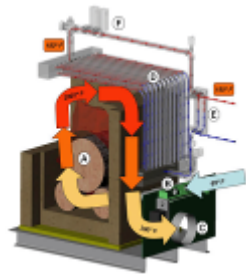
$$\frac{\Delta L}{L_0} = \alpha_L \Delta T$$



**Corporate Headquarters**

Columbus, Ohio USA

+1 614-876-0244

info@alliedmin.com

Global **Refractory** Solutions



Scan to view our locations

**alliedmineral.com**

